

ICC 1 S B / D

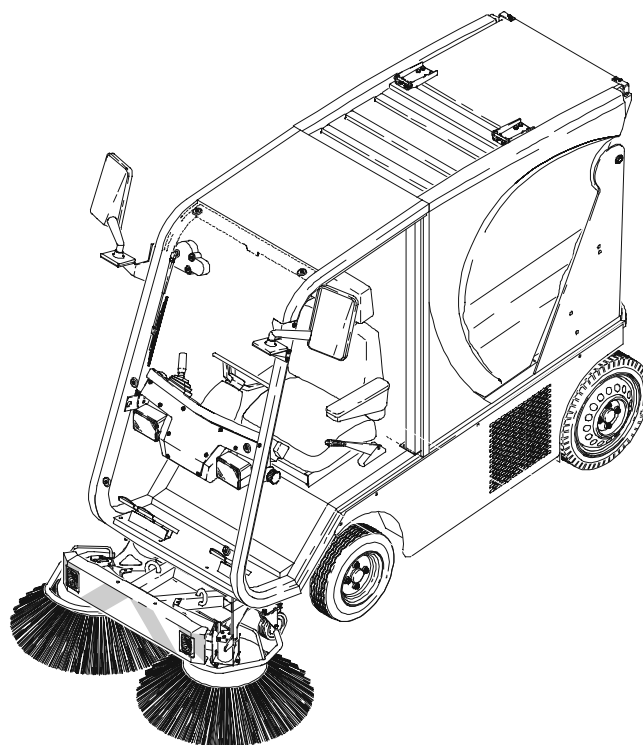

1.142-114
1.142-104

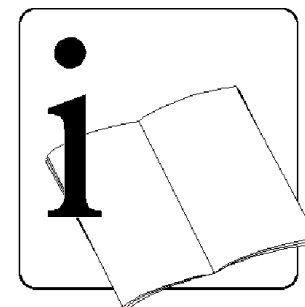

Betriebsanleitung	3
Ersatzteilliste	424
Operating instructions	26
Spare Parts List	424
Notice d'utilisation	48
Liste des pièces de rechange	424
Istruzioni per l'uso	72
Elenco pezzi di ricambio	424
Gebruiksaanwijzing	96
Reserveonderdelenlijst	424
Instrucciones de servicio	119
Lista de piezas de requesto	424
Manual de instruções	143
Lista de peças sobresselentes	424
Οδηγείο λειτουργείας	167
Ανταλλακτικά	424
Driftsvejledning	193
Reservedelsliste	424

Bruksveiledning	216
Reservedels liste	424
Driftinstruktion	238
Reservdelslista	424
Käyttöohje	260
Varaosalista	424
İşletme kılavuzu	283
Yedek parça listesi	424
Cihazın kullanım 10 yıldır.	
Üzemeltetési utasítás	306
Pótalkatrész lista	424
Návod k obsluze	329
Seznam náhradních dílů	424
Navodilo za upravljanje	352
Seznam nadomestnih delov	424
Instructiunile de folosire	375
Lista pieselor de schimb	424
Инструкция за работа	399
Списък на резервните части	424

Contents

For your own safety!	27			Maintenance intervals	35		
General notes	27	Switching the suction turbine on and off	30	Elapsed-time meter	35	Cleaning spray nozzles at side brushes	43
Risk of overturning on too high gradients!	28	Engine speed adjustment	30	Maintenance by the customer	35	Adjust suction orifice	43
Risk of overturning when taking bends rapidly!	28	Parking brake / foot brake	31	Maintenance by the customer service department	35	Replacing sealing strip suction opening	43
Danger of tipping over given an unstable travelling surface!	28	Before every operation	31	Maintenance tasks	36	Adjusting/replacing sealing strip of coarse-dirt flap	43
Danger of tipping over given a sideways incline that is too large!	28	Testing and maintenance work	31	Notes on safety	36	Replacing seal of debris container	43
		Commissioning	31	Check the engine oil level	36	Changing bulbs	44
		Start machine	31	Top up engine oil	36	Changing fuses	44
		Sweeping operation	32	Replace engine oil filter	36	Battery safety instructions	44
For our environment	28	Run machine	32	Check the hydraulic oil level	37	Removing and installing battery	44
		Stop machine	32	Checking fouling of hydraulic filter	37	Charge the battery	45
Intended use	28	Empty the swept material container	33	Top-up with hydraulic oil	37	Fault instructions	45
		Emptying debris container manually	33	Check hydraulic system	37	Accessories	45
Function description - sweeping machine	28	Usage instructions	33	Check and overhaul the water cooler	37	Technical data	46
		Safety instructions when sweeping	33	Cleaning and replacing fuel filter	38	EC conformity declaration	47
		Cleaning dry ground	33	Vent the fuel system	39		
		Cleaning damp or wet ground	33	Cleaning and replacing air filter	39		
		Sweeping in largish objects	33	Lubricating the front axle	40		
		Driving over obstacles	33	Lubricating the side brush raiser	40		
Before first operating	28	Decommissioning	34	Check V-belt	40		
Unloading instructions	28	Transport	34	Refill fuel	40		
Operating sweeping machine without automotive power	28	Transport instructions	34	Adjust driver seat	41		
Operating sweeping machine with automotive power (as supplied)	28	Cleaning and maintenance	34	Check the tyre air pressure	41		
		Cleaning	34	Changing wheels	41		
Operation	29			Checking and adjusting sweeping area of the side brush	41		
General overview	29			Replacing side brush	42		
Ignition switch	29			Filling up water container	42		
Indicator / dipped beam / parking light /horn	29			Emptying water container	42		
Warning flashlight	29			Clean and change water filter	42		
Lifting / lowering refuse container	30						
Lifting / lowering side brushes / speed adjustment	30						
Raise coarse-dirt flap	30						
Water pump	30						

For your own safety!

General notes

It is mandatory to read and observe this prior to using the appliance!

- Notify your sales outlet if during unpacking you detect damage that has occurred in transit.
- Read the operating instructions of your appliance prior to putting it into operation, especially the safety information.
- The warning signs and information labels attached to the unit provide important advice on its safe operation.
- In addition to the instructions in the operating instructions, general safety- and accident prevention-regulations from lawgivers must be followed.

Use

- Prior to utilization the appliance and its working facilities must be checked regarding their proper condition and that they operate safely. It must not be used if its condition is not faultless.
- No modifications permitted on the machine.
- The unit is intended for sweeping inside- and outside surfaces.
- Never absorb explosive liquids, inflammable gases or undiluted acids and solvents! This includes petrol, paint thinner or fuel oil, which can form explosive fumes due to the swirling suction air, in addition acetone, undiluted acids and solvents, since they corrode the materials used for the appliance.

- Do not sweep up/absorb burning or smouldering objects.

Only if expressly marked as such is this appliance suitable for sucking up health-hazardous dust types.

Comply with notices concerning safety regulations given in the operating instructions.

- Suitable only for the surfaces listed in the operating instructions.
- The appliance may be used on only the areas cleared for its use by the factory owner or a person authorized by him.
- Keep clear of the danger area. Its operation in explosion hazardous locations is prohibited.
- The following applies generally: Keep combustible materials away from the machine (danger of explosions-/fire).

Operation

- The rules, regulations and stipulations applying to motor vehicles must always be observed.
- The operator must use the unit in accordance with its intended purpose. She must adapt her mode of operation to the local conditions and when working with the appliance keep a look out for third parties, especially children.
- The appliance may only be used by persons instructed in its handling or who have proved their capability of operating it and who are expressly authorized to use it.

- The unit must not be operated by children and youths.
- To prevent unauthorized utilization of appliances provided with an ignition key the ignition key must be removed.
- The appliance must never be left unattended as long as the motor is running. The operator may not leave the appliance until the motor is turned off, the appliance is safeguarded against unintentional motion, if necessary the parking brake actuated and the ignition key removed.
- On slopes the angle of inclination to the side and in the direction of motion must not exceed the value given in the operating instructions.

Transport

- The motor must be turned off when the appliance is transported.
- The parking brake must be locked.
- Secure the machine with guy belts, ropes or chains.
- Immobilise the machine at the wheels with chocks.

Maintenance

- Prior to cleaning it and performing maintenance work, changing parts or setting it to another function the appliance is to be switched off and if necessary the ignition key removed.
- For battery-run appliances the battery plug must be pulled out of the socket prior to work on the electrical equipment, i.e. the battery is to be disconnected.

- Do not clean the appliance with jet streamers.
- Repairs may only be carried out by approved customer service centres or by technical personnel trained in this field which are familiar with all relevant safety regulations.
- Industrially used appliances in changing locations are subject to the safety inspection according to VDE 0701.
- Use only the brushes/discs with which the appliance is equipped or those specified in the operating instructions. The use of other brushes/discs can impair safety.
- The unit may not be cleaned with a hose- or a high pressure water jet (danger of short circuits or other damages).

Accessories and spare parts

- Only accessories and spare parts cleared by the manufacturer may be used. Original-accessories and original-spare parts ensure that the unit can be operated safely and trouble-free.

Riding appliances

- Riding appliances are not approved for public highways. Please ask your retailer for the conversion kit for street-worthiness.
- Giving companions lifts is not permissible.
- Riding appliances may be set in motion only from the seat.

Machines with a combustion engine

- The exhaust opening must not be sealed.
- Do not bend over or touch the exhaust opening (danger of burns).
- Do not touch or grasp the drive motor (danger of burns).
- Adequate ventilation and extraction of exhaust must be provided when operating the unit indoors. (Danger of poisoning)
- Exhaust gases are toxic and damaging to health; do not inhale them.
- The engine takes approx. 3...4 s to run down after being shut off. Never enter operating area during this period!

The following must be observed when refuelling machines provided with a combustion engine:

- Only the fuel specified in the operating instructions may be used. An explosion hazard exists with unsuitable fuels.
- The engine must be switched off.
- Do not fill-in fuel in closed rooms.
- Take care that no fuel splashes onto hot surfaces.
- Do not use any burning or smouldering objects during filling up or carry them with you or bring them in the vicinity of the appliance (explosion hazard).
- Fill the tank at the most 1 cm below the lower edge of the filler neck, since the fuel expands in heat.
- Wipe off spilled over fuel and close tank cap tightly.

Risk of overturning on too high gradients!



Danger!
The machine could topple over when driving and turning on slopes.

- Drive only on slopes up to 20 % in the travelling direction.
- At right angles to direction of travel only negotiate gradients up to a maximum of 10 %.

Risk of overturning when taking bends rapidly!



Danger!
The machine can topple-over when driving fast around curves.

- Drive slowly in curves.

Danger of tipping over given an unstable travelling surface!



Danger!
The machine can tip over given an unstable travelling surface.

- Move the machine exclusively on a solid travelling surface.

Danger of tipping over given a sideways incline that is too large!



Danger!
The machine can tip over given an incline of more than 10 %.

For our environment

Caution, danger to the environment from used batteries!



Do not dispose of exhausted batteries as ordinary household garbage.

- Ensure environmentally compatible disposal.

Caution, engine and hydraulic oils endanger the environment!



- Take spent oil after an oil change to an oil collecting point or a waste disposal company.

Intended use

- This sweeping machine is designed for sweeping surfaces in outdoor areas.
- It must not be used in enclosed spaces.
- No explosive substances or substances which are a danger to health may be swept up.
- It is utilizeable on public highways only after a previous individual acceptance by an authorized supervisory agency.

Function description - sweeping machine

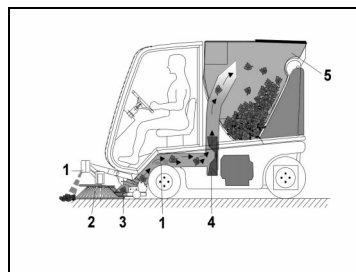

- The dust generated is bound by sprayed water (1).
- The two side brushes (2) convey the dirt in front of the suction orifice (3).
- The extractor fan (4) sucks up the refuse, chops it finely and conveys it to the refuse container (5).

Before first operating

Unloading instructions

- For safe transportation the machine was secured with taut belts, ropes or chains.
- Proceed as follows when unloading:
 - Apply parking brake
 - Remove the taut belts, ropes or chains from the transporting loops

Operating sweeping machine without automotive power

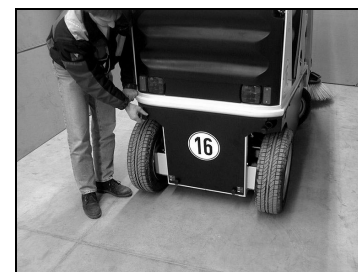

- Unscrew rear cover



- Shift overrunning lever (coasting operation)

Note:

When the sweeper is not self-powered do not move it over longer distances and not faster than 10 km/h .

Operating sweeping machine with automotive power (as supplied)

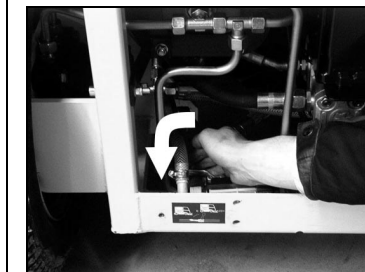

- Shift overrunning lever (driving mode)

Operation

General overview

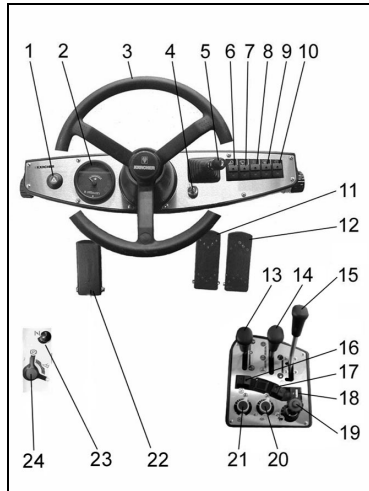

1. Warning flashlight
2. Display instrument
3. Steering wheel
4. Ignition switch
5. Combination switch
 - Direction indicator
 - Low beam
 - Parking light
 - Horn
6. Localised work illumination - side brushes (accessories)
7. Windscreen wipers
8. Heating (accessories)
9. Defroster fan (accessory)
10. Allround warning lamp (accessories)
11. Accelerator pedal - backwards
12. Accelerator pedal - forwards
13. Tip the swep material container
14. Lifting / lowering side brushes / speed adjustment
15. Lift / lower coarse refuse flap
16. Extractor fan
17. Water pump
18. Operating hour counter, sweeping unit (accessories)
19. Engine speed adjustment
20. Water quantity - side brushes
21. Water quantity - intake channel
22. Parking brake / foot brake pedal
23. Choke (only for ICC 1 S B)
24. Switch-over between parking brake and foot brake

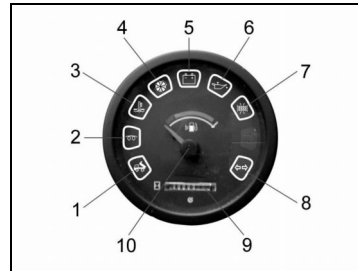

Display instrument

1. Debris container raised
2. Preglowing (only for ICC 1 S D)
3. Cooling water over temperature (additional sound signal)
4. Blower fan on
5. Battery charge indicator
6. Oil pressure
7. Air filter change indicator
8. Driving direction indicator
9. Running time meter - engine
10. Tank display

Ignition switch



- 0 = Ignition off / engine off.
- I = Preglowing on (only for ICC 1 S D) and operation.
- II = Start engine.

Indicator / dipped beam / parking light / horn



LEFT / RIGHT indicator.



Parking light



Dipped headlight



Sound horn

Warning flashlight



Switch hazard warning lights on / off.

Lifting / lowering refuse container

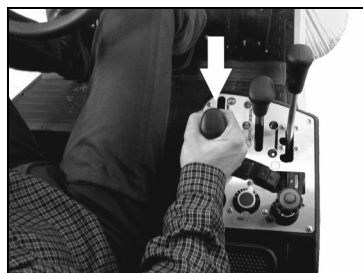

Raise swept material container

Lifting / lowering side brushes / speed adjustment



Lower side brush and start up

Raise coarse-dirt flap



➤ To vacuum isolated pieces of coarse-dirt briefly pull the lever right back.

Water pump



Switching water pump on / off (Dust binding)

Switching the suction turbine on and off



Switching the suction turbine on and off



Lower the swept material container

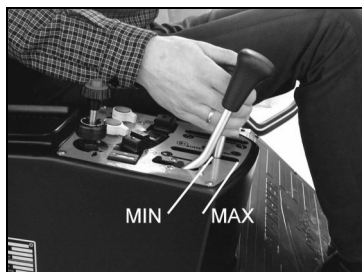

Side brush speed adjustment



- Engage the lever in position 1 for medium-sized debris, e.g. leaves.
- Engage the lever in position 2 for coarse debris, e.g. drinks cans.

Note:
Sand and grit are not collected when the coarse-dirt flap is raised.



Adjusting water quantity in the intake channel



Coarse adjustment
➤ Press button and simultaneously pull or press the rotary knob.

Pulled out: max. speed
Pushed in: min. speed



Raise the side broom



Adjusting water quantity onto the side brushes



Fine adjustment
 ➤ Counterclockwise:
 Increases speed
 ➤ Turn clockwise:
 Decreases speed



➤ Press brake pedal



Switch to operation mode "foot brake".
 ➤ Press and hold down brake pedal

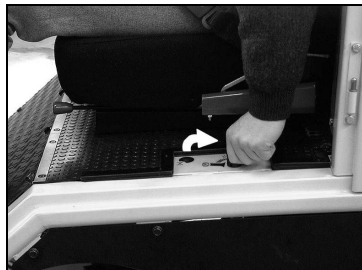

➤ Switch to operation mode "parking brake" ("P")



➤ Switch to operation mode "parking brake" ("P")

Before every operation

Testing and maintenance work

- Check the engine oil level
- Check the hydraulic oil level
- Check and overhaul the water cooler
- Check the tyre air pressure
- Refill fuel
- Adjust driver seat
- Check extractor fan port
- Check suction orifice setting
- Check lighting-technical system for function
- Check signal- and warning equipment for function
- Fill up water tank

See maintenance tasks chapter for description.



Warning!
 Established deficiencies must be removed immediately or the vehicle must be left still.

Commissioning

Start machine

- Sit on the driver seat
- Do not operate accelerator pedals
- Apply parking brake

ICC 1 S D



➤ Pull out engine speed adjustment 1/3.



Preheating
 ➤ Insert ignition key in ignition switch and turn to position "I"
 — Preheating pilot lamp lit



Start engine
 ➤ Turn the ignition key to position "II" when the preglow plug lamp goes out
 ➤ Release the ignition key when the engine has started

ICC 1 S B



➤ Pull out engine speed adjustment 1/3.



➤ Pull out the choke



➤ Start engine
 ➤ Turn ignition key to position "II"
 ➤ Release ignition key when engine starts
 ➤ Push in choke slowly when the engine is running

Sweeping operation



- Lower suction opening and side brush

Note:

Side brush turns on automatically.

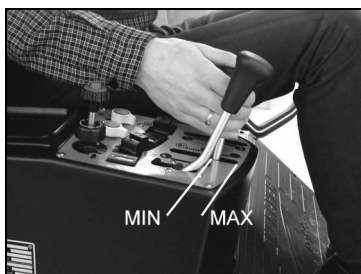

- Adjust the speed of the side brush



- Switch water pump on (dust consolidation)



- Adjusting water quantity in the intake channel



- Adjusting water quantity onto the side brushes



- Switch on blower fan

Note:

The water pump runs only when the blower fan is switched on.

Run machine



- Extract gas draught completely



- Press and hold down brake pedal

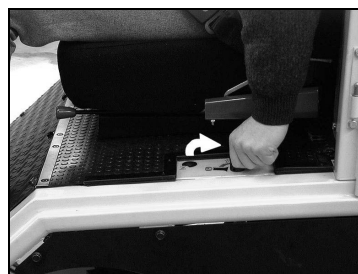

- Switch to operation mode "foot brake"

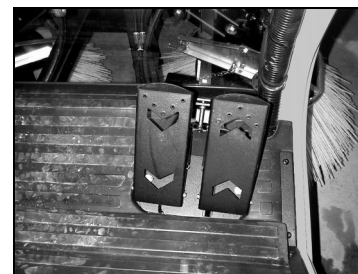

- Forward driving-r.h. pedal
- Reverse driving-l.h. pedal
- Slowly press the driving pedal.

Note:

A danger signal is emitted during reversing.

Driving behaviour

- The accelerator pedals allow an infinitely variable driving speed to be selected.
- If power drops on uphill slopes, ease off accelerator pedal.
- Avoid jerky operation of the pedal.
- Only change direction of travel once vehicle is stationary.



Braking

- Release the driving pedal; the machine brakes automatically and comes to a standstill.

Note:

The braking effect can be supported by pressing the foot brake.

Stop machine

- Switch on blower fan
- Switch off water pump
- Lift suction orifice and side brushes
- Apply parking brake
- Push engine speed adjustment all the way in
- Turn the ignition key to position "0" and remove it

Empty the swept material container



Danger!

Danger of injury!

- Travelling backwards should not endanger third parties, if necessary, receive training.
- Before emptying the refuse container turn off extractor fan.
- During the emptying process no persons and animals must remain within slewing range of the refuse container.



- Raise swept material container

Note:

A danger signal is emitted during lifting



Danger!

Danger of crushing!

- Never grasp into the rod system of the emptying mechanism.



- Lower the swept material container

Note:

A danger signal is emitted during lowering



Danger!

Danger of tipping!

- Empty the swept material container only while standing on a level surface.
- When evacuating on waste dumps or on ramps, be sure to stay a safe distance away.



- Shut-off the suction fan
- Lift suction orifice and side brushes
- Apply parking brake

Emptying debris container manually



Raise swept material container

- While pumping, push and hold the "Raise/Lower Debris Container" operating lever in position "Raise".



Lower the swept material container

- While pumping, push and hold the "Raise/Lower Debris Container" operating lever in position "Lower".

Note:

The add-on kit 2.639-500 is required to be able to empty the sweepings container manually.

Usage instructions

Safety instructions when sweeping



Warning!

- Do not sweep in packing bands, wires or similar items, this can cause damage to the extractor fan unit.

Cleaning dry ground

- The water pump must be activated to avoid deposits in the suction channel.
- Depending on refuse and dust formation, switch on water pump to the side brushes. Measuring out water quantity.

Cleaning damp or wet ground

- If formation of dust does not appear, turn off water supply to the side brush.

Note:

To attain an optimum cleaning result the driving speed must be adapted to suit the prevailing conditions.

Sweeping in largish objects

The coarse refuse flap can be opened for sweeping in largish objects (e.g. tins or great amounts of leaves).

Note:

The operator can see his working range through the suction opening mirror.

Driving over obstacles



Warning!

- Lift side brushes and suction orifice.

Obstacles up to a height of 150 mm

- Drive over forwards, slowly and carefully, at an angle of 45°.

Obstacles above a height of 150 mm

- May only be driven over using a suitable ramp.

Note:

Ensure that the vehicle does not come to a halt.

Decommissioning

Please heed the following if sweeper is not to be used for a lengthy period.

- Stand sweeper on a flat surface
- Lift side brushes, in order not to damage the bristles
- Remove the ignition key
- Safeguard the sweeping machine from rolling away
- Fill the fuel tank completely and close the fuel tap
- Change the engine oil
- If frost is expected, drain-off the cooling water or make sure that it contains sufficient anti-freeze agent
- Clean inside and outside of sweeper
- Empty water container and pipe system
- Disconnect the batteries and charge at intervals of 2 months

Transport

Transport instructions



Warning!

When it is transported the machine must be secured against dislocation.

- Apply parking brake
- Secure machine to the ring bolts with tension belts, ropes or chains
- Secure the machine with wedges on the wheels

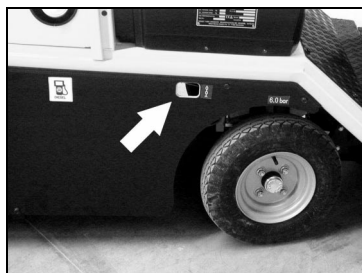

Transport ring FRONT



Transport ring BACK

Cleaning and maintenance

- Stand sweeper on a flat surface.
- Lift suction orifice and side brushes.
- Apply parking brake.
- Raise swept material container.
- Shut-off the engine.
- Remove the ignition key.

Cleaning



Danger!

Wear safety goggles!



- Pull out safety split pins

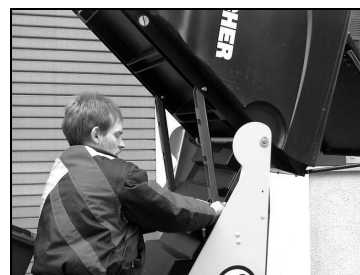

- Lower safety supports on left and right and secure with split pin



- Open container cover fully
- Pull out safety split pins



- Lift off container cover supports on the frame and hang up on the refuse container
- Secure with safety cotter pin



- Clean coarse dirt from the refuse container with scraper



- Clean refuse container with Kärcher high-pressure cleaner



- Clean built-up surfaces from the fan conduit with Kärcher high-pressure cleaner



- Clean suction orifice with Kärcher high-pressure cleaner

! Danger!

After it has been turned off the suction turbine runs-out for a few seconds.

Open the maintenance flap only 30 sec. after switching off or stop of the suction turbine.

Note:

The suction turbine is automatically stopped and braked if the debris container is raised or the seat flap is opened while the suction turbine is switched on.

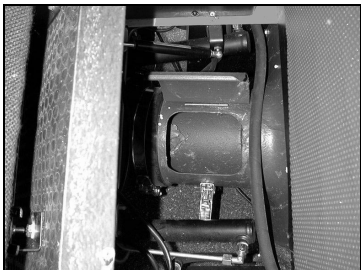

- Clean fan conduit under the seat with Kärcher high-pressure cleaner



- Detach the radiator grille

Note

The cooler may not be cleaned unless the engine is switched off.

The cooler is to be cleaned outwards from the inside with compressed air or a low-pressure water jet.

It is not to be cleaned with a high-pressure cleaner.

Do not use any aggressive cleaning agents!



- Unscrew engine cover

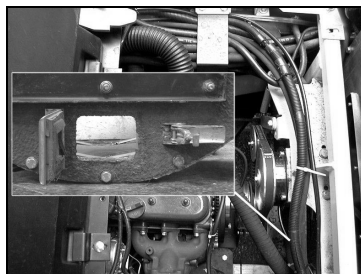

- Allow water in the fan casing to drain off by opening the butterfly valve

Note:

The machine must be cleaned daily after the work is finished.

Maintenance intervals

Elapsed-time meter

When maintenance is due can be seen at the "Engine" operating hour counter.

Maintenance by the customer

Daily maintenance

- Check the engine oil level
- Check the cooling water level
- Check the tyre air pressure
- Check side brushes and fan for wear and tear and wound-up bands
- Clean radiator

Additional maintenance once a week

- Check the hydraulic oil level
- Clean water filter (more often, depending on water quality)

Additional maintenance every 100 hours/ once a year

- Change the engine oil
- Change engine oil filter cartridge
- Lubricate front axle bearing
- Lubricate the bearings of the side broom lifter
- Check fan belt and round belt for wear and tear
- Clean fuel filter (only for ICC 1 S D), replace, if necessary (ICC 1 S D/B)
- Check fuel hose and clamp
- Clean air filter
- Check fouling indicator of hydraulic filter

Additional maintenance every 200 hours/ every six months

- Check the cooler hoses and clamps

Note:

All service and maintenance work must be carried out solely by a qualified employee.

Consult Kärcher Service, if necessary.

Maintenance by the customer service department

Maintenance after 20 operating hours

First inspection

Maintenance operations every 400 operating hours/ every six months

Maintenance operations every 1200 operating hours

Note:

To safeguard warranty rights, during the warranty period all service and maintenance work must be performed by an authorised Kärcher after sales service.

Maintenance tasks

Notes on safety

 **Warning!**

Preparations

- Stand sweeper on a flat surface
- Remove the ignition key
- Apply parking brake

- When the refuse container is raised, always lower the safety supports and secure with split pin.

— Wear warning clothing when performing repair work on public streets where it is dangerous because of moving traffic .



- Lower safety supports on left and right and secure with split pin



- Unscrew engine cover

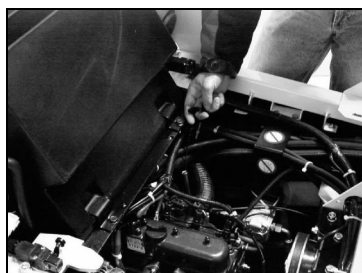

- Pull-out the oil dip rod
- Wipe off oil dip stick and slide it in again

Check the engine oil level

Wait at least 5 minutes after stopping engine before performing the check.



- Raise swept material container
- Pull out safety split pins

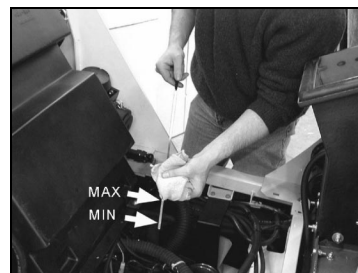

- Pull-out the oil dip rod
 - The oil level must be between the "Min" and the "Max" marks.
 - Top up the engine oil if the oil level is below the "Min" mark.
 - Do not fill up beyond "Max".

Top up engine oil

 **Danger!**

Let the engine cool-down.



- Release the cap screw of the oil-filling opening

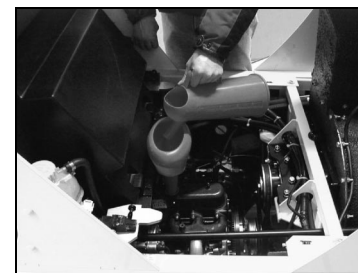

- Fill-in engine oil
 - Oil types: See technical data
- Close the oil fill opening
- Wait for at least 5 minutes
- Check the engine oil level

Change the engine oil



- Provide a collecting container for at least 4 litres of oil
- Allow the engine to cool off a little
- Unscrew drain plug

 **Danger!**

Risk of burning if oil is hot

- Use a new seal without fail when screwing the drain plug in again
- Tighten drain plug to 25 Nm with a torque wrench

Replace engine oil filter



- Unscrewing the side shrouding

Note:

Perform an engine oil filter change together with the engine oil change.



- Unscrew oil filter



- Clean the supporting and sealing surfaces



- Wet the gasket of the new oil filter with oil before mounting
- Hand-tighten new oil filter
- Fill-in engine oil
- Check the engine oil level



- Take spent oil after an oil change to an oil collecting point or a waste disposal company.

Check the hydraulic oil level

— An inspection glass is provided for checking the fill level in the hydraulic oil tank. At the inspection glass the "max" level is marked by a black line and the "min" level by a red line.



Oil inspection glass

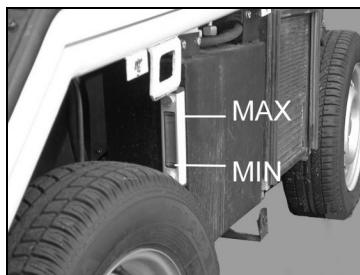

— The oil level must be between the "Min" and the "Max" marks.

Checking fouling of hydraulic filter

- Unscrewing the side shrouding
- Apply parking brake
- Pull out engine speed adjustment 1/3
- Start engine

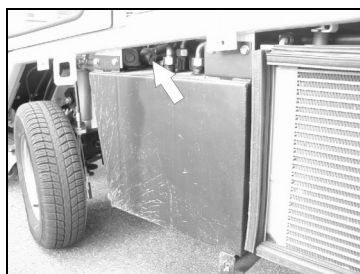

Hydraulic filter fouling indicator



- Check hydraulic filter fouling indicator while the oil is warm



Warning!

- The filter element must be replaced when the indicator is at the red mark

Top-up with hydraulic oil



- Clean filling area
- Loosen filler cap



- Take out oil filter with oil filter casing



- Take oil filter out of the oil filter casing
- Replace oil filter if required

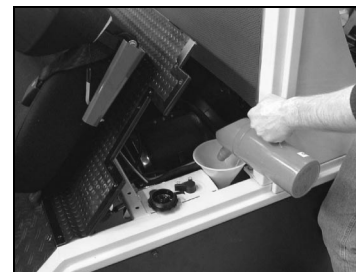

- Refill hydraulic oil (see Technical Data for the grade)
- Rectify the hydraulic oil level from "Min" to "Max"
- Keep the opening clean

Check hydraulic system

- Check all hydraulic hoses and connections to make sure that they are not leaking.
- Please consult the Kärcher after sales service for maintenance of the hydraulics.

Check and overhaul the water cooler



Danger!

Danger of scalding due to boiling water!

- Let cooler cool off at least 20 Min.



- Raise swept material container
- Pull out safety split pins

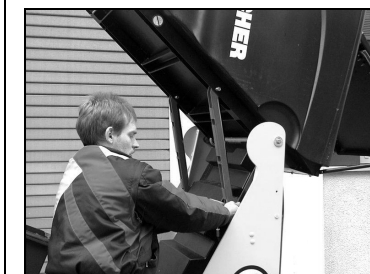

- Lower safety supports on left and right and secure with split pin



- Top up cooling water in the cooling water compensator reservoir



- Raise swept material container
- Pull out safety split pins

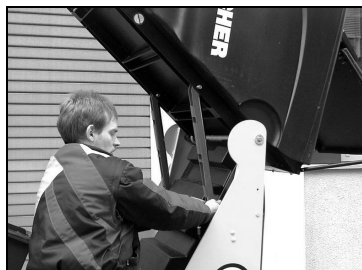

- Lower safety supports on left and right and secure with split pin



- Unscrew engine cover

When engine is cold

- Cooling water level above the lower mark.

When engine is hot

- Cooling water level below the upper mark.
- The cooling water must not contain more than 50% anti-freeze agent!
- See chapter Cleaning and Care for cleaning of cooling gills and ventilator.

Cleaning and replacing fuel filter



Danger!

Explosion hazard

- Do not carry out maintenance tasks in closed rooms.
- Shut-off the engine.
- Smoking and naked flames prohibited.

Only for ICC 1 S D



- Close the fuel feed line

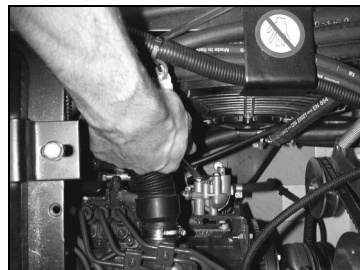

- Unscrew fuel filter



- Remove union nut and lift off fuel filter together with its contents



- Clean or replace fuel filter



- Replace the gasket ring



- Clean fuel filter casing

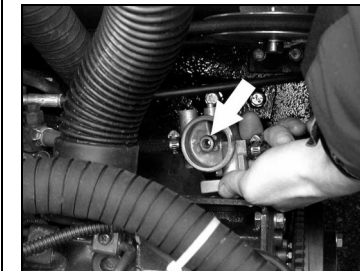

- Replace the gasket ring



- Tighten union nut until fingertight



- Screw on fuel filter

Only for ICC 1 S B



- Close the fuel feed line

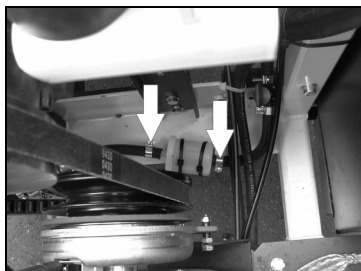

- Detach hose clamps at connectors of fuel filter
- Lift out fuel filter

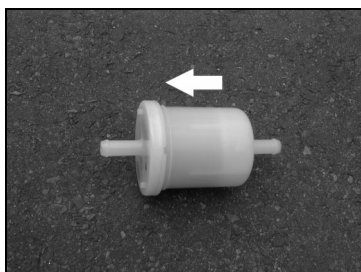

- Note flow direction when mounting the new filter
- Insert new fuel filter in the accessory hose and tighten hose clamps
- Open fuel supply

General check

- Check the fuel hoses and clamps for leaks and damage
- Open the fuel tap
- Ventilate fuel system (only for ICC 1 S D)

Vent the fuel system

Only for ICC 1 S D



- Raise swept material container
- Pull out safety split pins

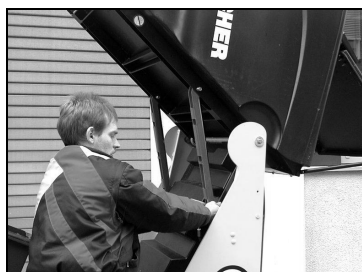

- Lower safety supports on left and right and secure with split pin



- Unscrew engine cover

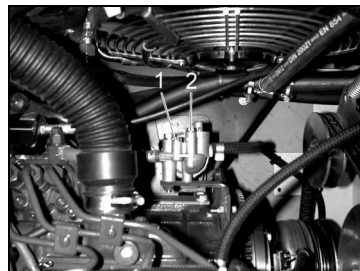

- Unscrew vent screws 1 and 2 by approx. 2 turns
- Provide a suitable drip pan for the fuel
- Start the engine until fuel without air bubbles comes out
- Tighten vent screws 1 and 2

Cleaning and replacing air filter

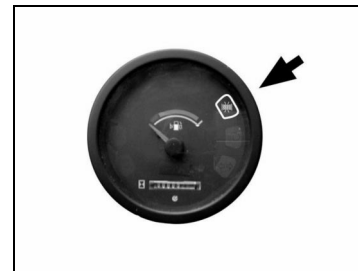

- If the red air filter control display lights up, the air filter is to be cleaned or to be changed.



- Raise swept material container
- Pull out safety split pins

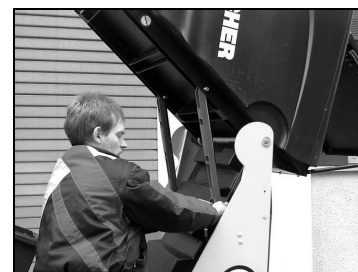

- Lower safety supports on left and right and secure with split pin



- Loosen sealing cover clips



- Take off the lid

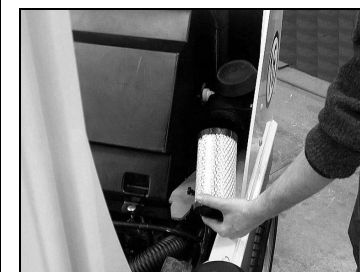

- Take out AND clean filter cartridge
- If necessary, use a new filter cartridge



- Clean sealing cover
- Put on sealing cover and clamp tight



- Grease lubricating nipple on the right of the front axle



- Grease lubricating nipple on the left of the front axle

Lubricating the front axle



- Grease lubricating nipple in the middle of the front axle

Lubricating the side brush raiser

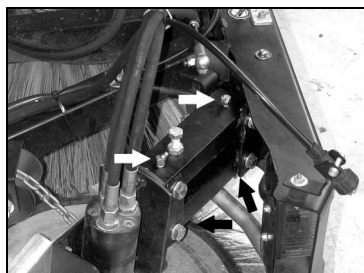

- Grease both grease nipples at the top and at the bottom sides of the side broom lifter

Check V-belt



- Raise swept material container
- Pull out safety split pins



- Lower safety supports on left and right and secure with split pin

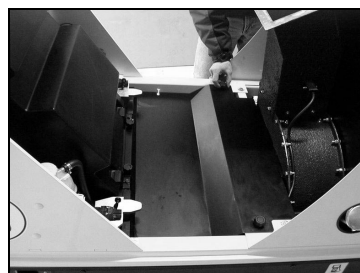

- Unscrew engine cover



- Check blower fan drive V-belt for damage and wear

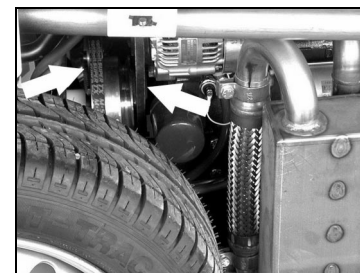

- Check hydraulic pump V-belt drive and the generator drive for damage and wear

Note:

The fan belts are tensioned by a spring.

Refill fuel



Danger!

Explosion hazard

- Do not fill-in fuel in closed rooms.
- Shut-off the engine.
- Smoking and naked flames prohibited.

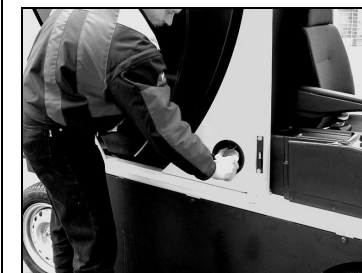

- Open tank cap.



- Refuel with DIESEL (only for ICC 1 S D) or with unleaded premium petrol (only for ICC 1 S B).

Refuelling using the canister

- Estimate the amount of fuel beforehand to prevent overflowing.

Refuelling using the nozzle

- Insert nozzle as far as possible into the filler pipe. As soon as the correctly operated fuel pump nozzle has cut out for the first time, do not continue refuelling.

Adjust driver seat

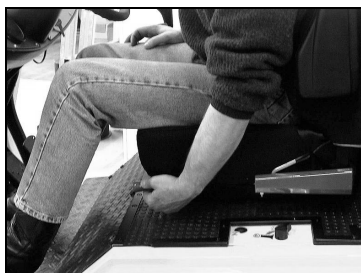

- Press seat release device outwards
- Displace the seat
- Release the seat unlatching device
- Lock the seat by moving backwards and forwards



- Adjusting back-rest inclination.
- Disengage back-rest
 - Pull back-rest release device upwards
 - Inclination can be changed by the position of the upper body
 - Let go of release device

Check the tyre air pressure

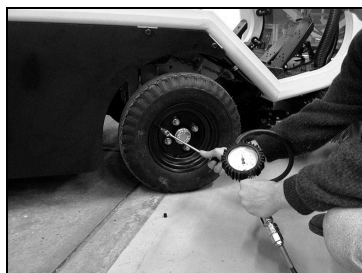

- The air pressure in the front tyres must be set to 2,9 bar.



- The air pressure in the rear tyres must be set to 2,9 bar.

Changing wheels



Danger!

Preparations

- Stand sweeper on a flat surface
- Remove the ignition key
- Apply parking brake
- Wear warning clothing when performing repair work on public streets where it is dangerous because of moving traffic .
- Check that the ground is stable
- Protect the machine additionally from moving with a wheel chock

Recommended express assistance:

- Check the tyre tread for imbedded objects
- Remove the objects
- Use a suitable, commercially available tyre repair agent

Note:

*Comply with the recommendations of the respective manufacturers
Continuing the journey is possible if the recommendations of the product manufacturer are observed
Change the tyre or the wheel as soon as possible*



Jack fixing point (front wheels)



Jack fixing point (rear wheels)

- Feed Ø 20 mm steel rod into the specified bore hole
- Place the jack in position
- Unscrew the wheel nuts
- Lift the machine with the jack
- Remove the wheel nuts
- Slide the wheel off
- Position the spare wheel
- Mount the wheel nuts
- Lower the machine with the jack
- Tighten the wheel nuts

Note:

*Heed the symbol labels (jack) at the respective wheel change positions
Use suitable, commercially available jacks*

Checking and adjusting sweeping area of the side brush

- Check the tyre air pressure
- Raise the side broom
- Drive sweeper over a flat, smooth surface covered with a clear layer of dust
- Lower side brush and start up.
- Raise the side broom
- Drive aside backwards
- Check the sweep mirror

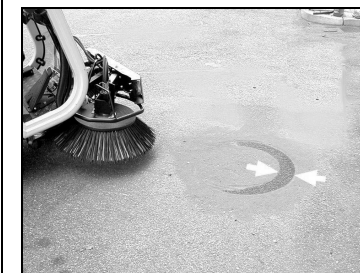

1. The sweeping area should be between 40 and 50 mm wide.



Adjusting the width of the sweep mirror.

2. Width of sweeping range can be adjusted by altering stop:
 - By turning the screw clockwise the sweeping area becomes smaller
 - By turning the screw anti-clockwise the sweeping area becomes larger

Replacing side brush

- Apply parking brake
- Raise the side broom



- Loosen hand nuts and remove side brush
- Screw-on the new side broom



Water level gauge for water container.

Filling up water container



- Unscrew container cover
- Filling up water container

Note:
The water hose must not be inserted while filling the water reservoir (to avoid back absorption).

Emptying water container



- Unscrew rear cover



- Close shut-off valve

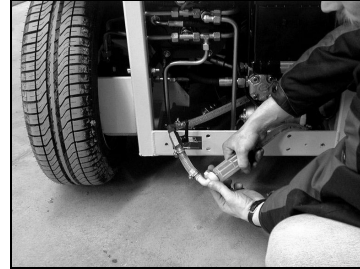

- Loosen union nut



- Open shut-off valve

Clean and change water filter



- Unscrew rear cover



- Close shut-off valve



- Loosen union nut



- Unscrew the water filter housing



- Clean or replace water filter



- Clean the water filter housing



- Check rubber seals

Cleaning spray nozzles at side brushes



- Unscrew union nut
- Take off spray nozzle
- Remove conical nipple

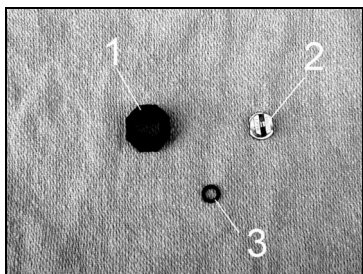

Clean spray nozzle

1. Union nut
2. Spray nozzle
3. Conical nipple

Adjust suction orifice

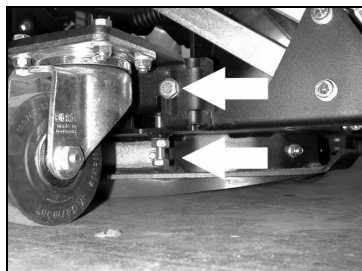

- Drain off suction orifice
- Unscrew the rollers' lateral fixing screws (1)
- Set track rollers at adjusting screw (2) so that the side sealing strips touch the floor at the front and are 18 mm above the floor at the rear.
- Tighten fastening screws of the rollers
- Lift suction orifice

Note

If the rollers can no longer be lowered to the ground they must be replaced.

Replacing sealing strip suction opening

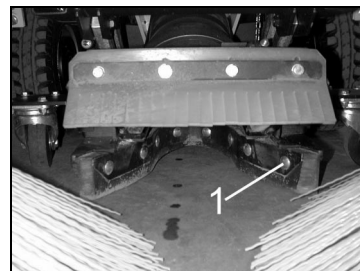

- Drain off suction orifice
- Lift the suction opening by adjusting the rollers
- Remove the seal fixing screws (1)
- Detach the stabilizing plate
- Insert the new seal and screw it and the stabilizing plate down

Note:

The whole length of the sealing strip must fit against the top of the holder.

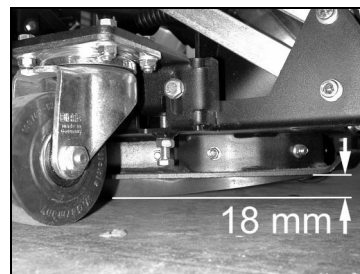

- Adjust suction orifice
- When mounted correctly, at the rear of the suction opening the seal has a clearance from the ground of approx. 18 mm.

Adjusting/replacing sealing strip of coarse-dirt flap

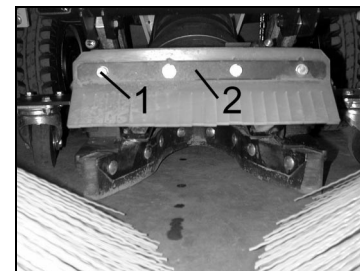

Adjust the seal

- Drain off suction orifice
- Unscrew the seal fixing screws (1)

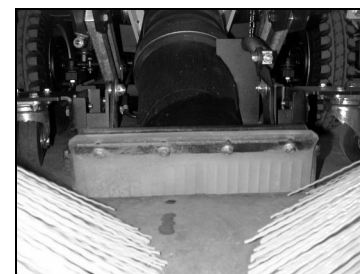

- Adjust the seal such that it touches the ground when the coarse refuse flap is closed
- Fasten the seal

Replace the seal

- Remove the seal fixing screws (1)
- Detach the stabilizing plate (2)
- Insert the new seal and screw it and the stabilizing plate down
- Adjust the seal

Replacing seal of debris container

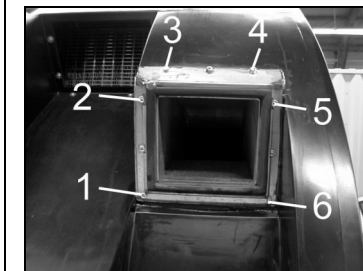

- Raise swept material container
- Remove the retaining plate's fixing screws (1) - (6)
- Detach the retaining plate and the seal
- Clean the sealing surface
- Fasten the new seal and the retaining plate

Changing bulbs



- Unscrew the hexagonal head screws of the headlight holder



- Pull the headlight casing apart
Hold the headlight casing horizontally; the headlight is not attached.



- Take-out the headlight and disconnect the cable plug
Note the position of the plug

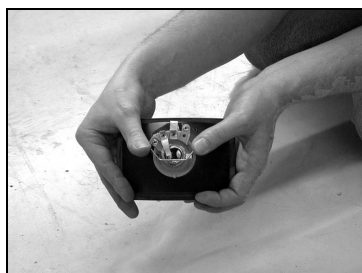

- Unlatch the lamp mounting closing bracket and take out the lamp bulb
- Replace bulb

Note:
Assembly is carried out in reverse order.

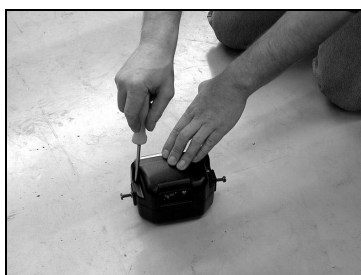

- Unscrew the headlight casing to take it apart

Changing fuses



- Fuses/relays in vehicle tail
1. Electric fan relay
 2. Preglow relay (only for ICC 1 S D)
 3. Fuse for electric fan
 4. Fuse for ignition coil and preglowing (only for ICC 1 S D)

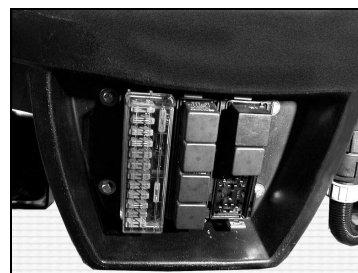

- The fuse box is in the instrument panel beneath the steering wheel.
- Replacing blown fuses
 - Use only fuses with the same current rating

Battery safety instructions



Warning!

- Observe the operating instructions.
- Work on batteries is permitted only after instruction by trained personnel.



Danger!

*Risk of fire and explosion!
Do not place any objects or tools on the battery because voltage is always present between the battery poles.
Areas in which batteries are charged must be well ventilated, as highly explosive gas forms during charging.
Smoking prohibited.
No naked flames, glowing embers or sparks in the vicinity of batteries.*

Danger of acid burns!

- Wear safety goggles and protective clothing.
- Observe regulations for the prevention of accidents as well as DIN VDE 0510, VDE 0105 T.1.
- Rinse out or rinse off splashes of acid in the eye or on the skin with copious quantities of clean water.
- Then consult a doctor immediately.
- Wash contaminated clothing with water.



- Old batteries with this symbol are reusable commodities and must therefore be returned for recycling.
- Old batteries which are not returned for recycling must be disposed of as special waste, thereby observing all statutory regulations.

Removing and installing battery



- Unscrew rear cover
- Unscrew negative pole terminal

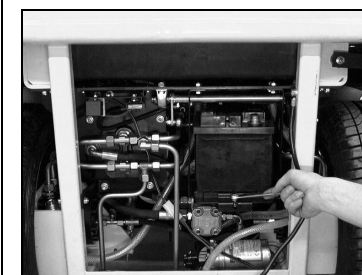

- Unscrew the battery holder
- Take out battery



- Unscrew positive pole terminal
- Take out battery

Note:

When installing the battery, ensure that the positive pole terminal is connected first.

Protect the battery poles and pole terminals against corrosion with pole protection grease.

Charge the battery



Warning!

Always heed safety precautions for handling batteries!

- Charge the battery only with a suitable battery charger.
- It is essential to observe the instructions provided by the manufacturer of the charging unit.

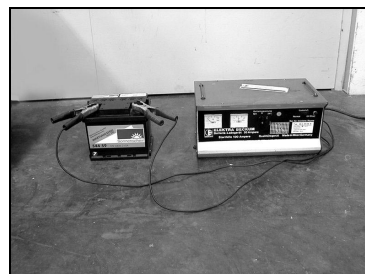

- Connect battery charger to correct poles and then connect to the mains.

Note:

When battery is recharged, disconnect battery charger first from the mains and then from the battery.

Fault instructions

The engine will not start or runs irregularly after starting

- Charging or replacing battery.
- Refuel.
- Ventilate fuel system (only for ICC 1 S D).
- Clean or replace fuel filter.
- Repairing fuel pipe.
- Tighten the connections.
- Clean the air filter or replace the filter cartridge.
- Inform Kärcher service.

Engine overheated (visual and sound signal)

- Top up coolant.
- Clean radiator.
- Check fuse/relay.
- Inform Kärcher service.

Sweeping machine is moving only slowly or not at all

- Release parking brake.
- Turn free-wheel lever.
- Clean the tyres or drive through a cleaning solution.
- Inform Kärcher service.

Whistling noise in the hydraulic system

- Top up hydraulic fluid.

Side brushes are rotating only slowly or not at all

- Removing strings and bands.
- Inform Kärcher service.

Dust formation

- Switch on water pump.
- Clean water nozzles.
- Top up water.
- Readjust water quantity.
- Inform Kärcher service.

Sweeper unit does not pick up refuse.

- Empty the swept material container.
- Set engine speed correctly (2700 1/min).
- Adjust the distance from the suction opening to the travel path (18 mm).
- Replace rollers.
- Replace fan belt.
- Increase engine speed (max. 2700 1/min).
- Clean intake channel.
- Empty the swept material container.
- Clean spent air protective grille.
- Inform Kärcher service.

Bin cannot be raised or lowered.

- Switch off fan.
- Inform Kärcher service.

Problems with hydraulically actuated components.

- Inform Kärcher service.

Accessories

Note:

Mounting kit for new vehicles are also available ex works.



Doors and defroster fan

2.639-140

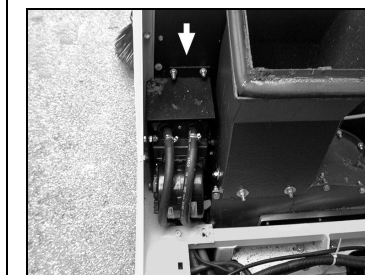

Heating

2.639-141



Flashing warning light 2.639-142

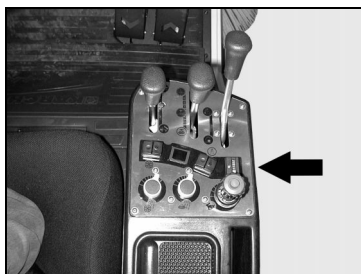

Suction turbine h-counter 2.639-143



Catalytic exhaust gas converter (only for ICC 1 S D) 2.639-145



Localized work illumination 2.639-301

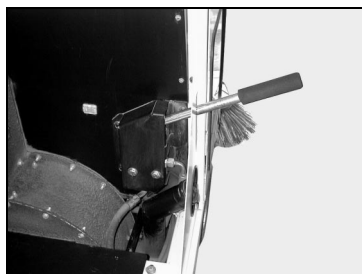

Manual lifting of sweepings container 2.639-500



Water drain add-on kit for debris container 2.639-584

- Luxury seat** 2.639-209
- Cleaning rod** 2.639-401
- MOT report according to CUR(StvZO §21)** 2.639-494
- Standard side broom** 6.906-085
- Professional side broom** 6.906-129
- Hard side broom** 6.906-194
- Soft side broom** 6.906-201
- Local painting** on request
- Individual painting** on request
- Personalising** on request

Technical data

Performance data

Theoretical coverage capability 12500 m²/h
 Operating speed 0...10 km/h
 Gradability 20 %

Engine (ICC 1 S D)

Manufacturer Kubota
 Model D722-BBS
 Construction 3-cylinders-four-stroke-Diesel engine
 Cooling mode water-cooled
 Bore 67 mm
 Stroke 68 mm
 Displacement 719 cm³
 Operating engine speed 2700 1/min

Idling speed 800-900 1/min
 Engine output 14 KW/19 PS
 Maximum torque 45 Nm at 2400-2900 1/min

Fuel filter Filter cartridge
 Tank contents approx. 30 litres
 Operating time with full tank 16 h
 Amount of oil in engine approx. 3,8 litres

Engine (ICC 1 S B)

Manufacturer Kubota
 Model DF750
 Design 3-cylinder-four-stroke-Otto engine
 Cooling mode water-cooled
 Bore 68 mm
 Stroke 68 mm
 Displacement 740 cm³
 Operating engine speed 2700 1/min
 Idling speed 800-900 1/min
 Engine output 17 KW/23 PS
 Maximum torque 38 Nm at 2400-2900 1/min

Fuel filter Filter cartridge
 Tank contents approx. 30 litres
 Operating time with full tank 10 h
 Amount of oil in engine approx. 3,8 litres

Type of oil in engine

More than 25°C SAE 30
 SAE 10W-30
 SAE 10W-40
 0 to 25°C SAE 20
 SAE 10W-30
 SAE 10W-40
 Below 0°C SAE 10W
 SAE 10W-30
 SAE 10W-40

Oil filter Filter cartridge
 Suction air filter external filter cartridge

Electrical system

Battery 12 V, 44 Ah
 Generator with regulator three-phase 12 V, 65 A
 Starter Electric starter

Tyres

Front size 145/80 R10
 Air pressure - front 2,9 bar
 Rear size 165/65 R13
 Air pressure - rear 2,9 bar

Brake

Front wheels mechanical
 Rear wheels hydrostatical

Travelling speeds

Forwards 0 - 16 km/h
 Backwards 0 - 8 km/h

Hydraulic system

Amount of oil in the entire hydraulic system approx. 35 litres
 Amount of oil in the hydraulic tank approx. 20 litres
 Type of oil HV 46

Bin

Max. unloading height 1350 mm
 Sweep container volume
 - Total capacity 550 litres
 - Usable weight 300 kg

Side brush

Speed (infinitely adjustable) 0 - 160 1/min

Dimensions and weights

Working width 900-1400 mm
 Length 2834 mm
 Width 980 mm
 Height 1897 mm
 Turning radius 3000 mm

Net weight 1200 kg

Noise emission

Sound level (EN 60704-1) 78 dB (A)
 Guaranteed noise level (2000/14/EU) 107 dB (A)

Degree of protection

Protected against splashing water

Machine vibration

Total vibration value (ISO 5349)
 Upper limb measurements < 2,5 m/s²
 Feet/seating area < 0,5 m/s²

Ambient conditions

Temperature -5 to +40°C
 Non-dew developing air humidity 0 - 90%

EC conformity declaration

We hereby declare that the machine specified below as the marketed design, the machine specified below complies with the relevant fundamental safety and health requirements of the EC directives listed below.
 Modification of the machine without our approval invalidates this declaration.

Product: Vacuum sweeper

Type: 1.142-xxx

Relevant EC directives

EC machine directive (98/37/EC)
 EC directive on electromagnetic compatibility (89/336/EEC) amended by 91/263/EEC, 92/31/EEC, 93/68/EEC
 EC guideline on noise emissions (2000/14/EU)

Applied harmonised standards

DIN EN 292-1
 DIN EN 292-2
 DIN EN 60335-1
 DIN EN 60335-2-72
 DIN EN 50082-2:1995
 DIN EN 13019

Applied national standards

CISPR 12
 BGV D 29
 DIN 30701
 DIN 30704-1

Test principles of Principal Organisation of the Commercial Employers' Liability Insurance Associations for Vacuum Sweepers

Applied conformity valuation method

Appendix V

Measured noise level:

D: 105 dB(A), B: 95 dB(A)

Guaranteed noise level:

D: 107 dB(A), B: 97 dB(A)

Internal measures ensure that the in series produced units always comply with the requirements of current EC directives and applied standards. The signatories act for and in authority of management.

5.957-586 (09/04)

Alfred Kärcher Limited Partnership.
 Registered office: Winnenden.
 Company Register: Waiblingen, HRA 169.

Personally liable partner. Kärcher Reinigungstechnik GmbH.
 Registered office Winnenden, 2404 Waiblingen Company Register, HRB

Managing directors:
 Dr. Bernhard Graf, Hartmut Jenner,
 Georg Metz

Alfred Kärcher GmbH & Co. KG
 Cleaning Systems
 Alfred-Kärcher-Strasse 28-40
 P.O.Box 160
 D-71349 Winnenden
 Phone: ++49 7195 14-0
 Fax :++49 7195 14-2212

 (Reiser Jenner)

KÄRCHER ICC 1

1.142-114.0 D
1.142-114.0 B

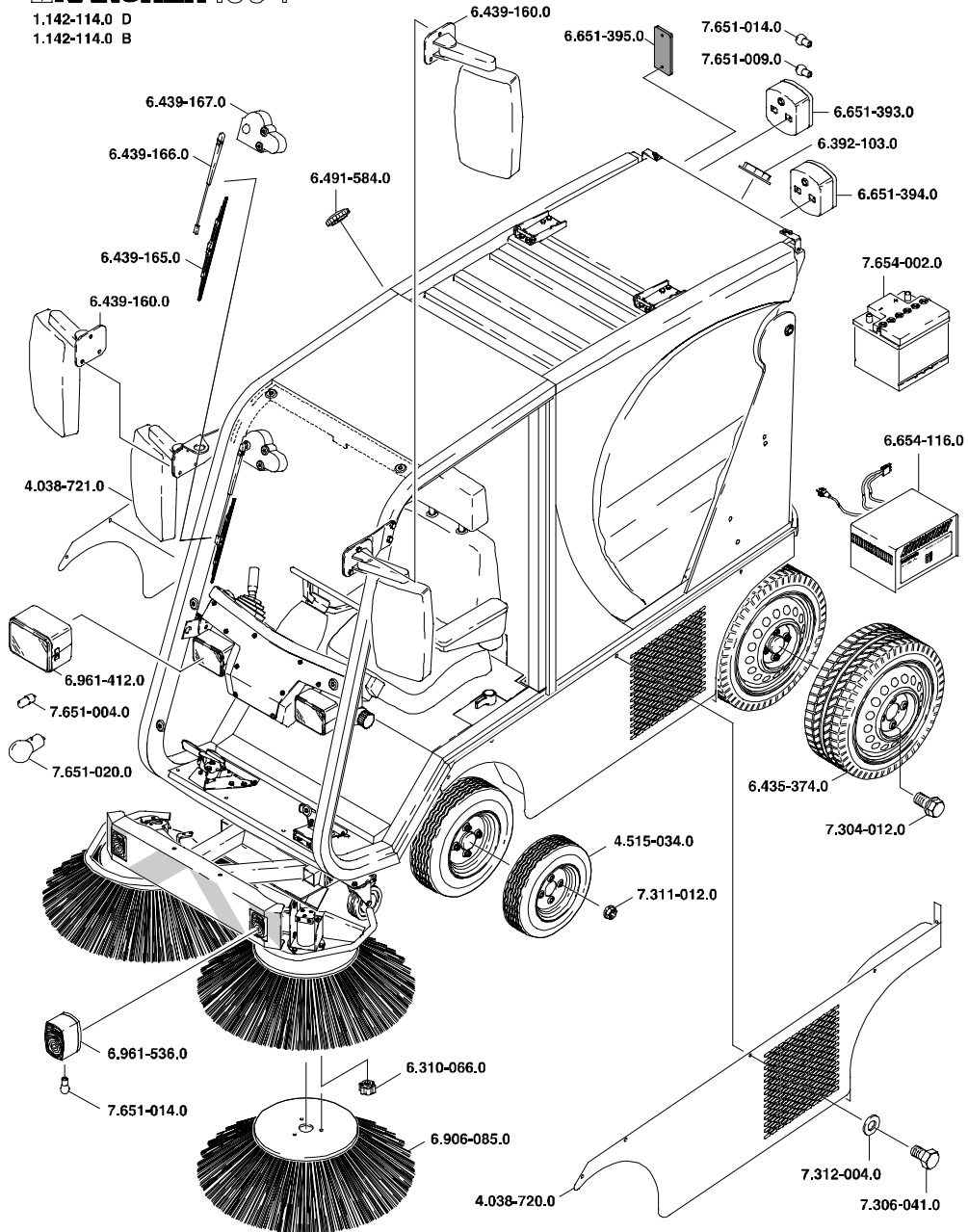

12.07.2001 - 07/01

KÄRCHER ICC 1

1.142-114.0 D
1.142-104.0 B

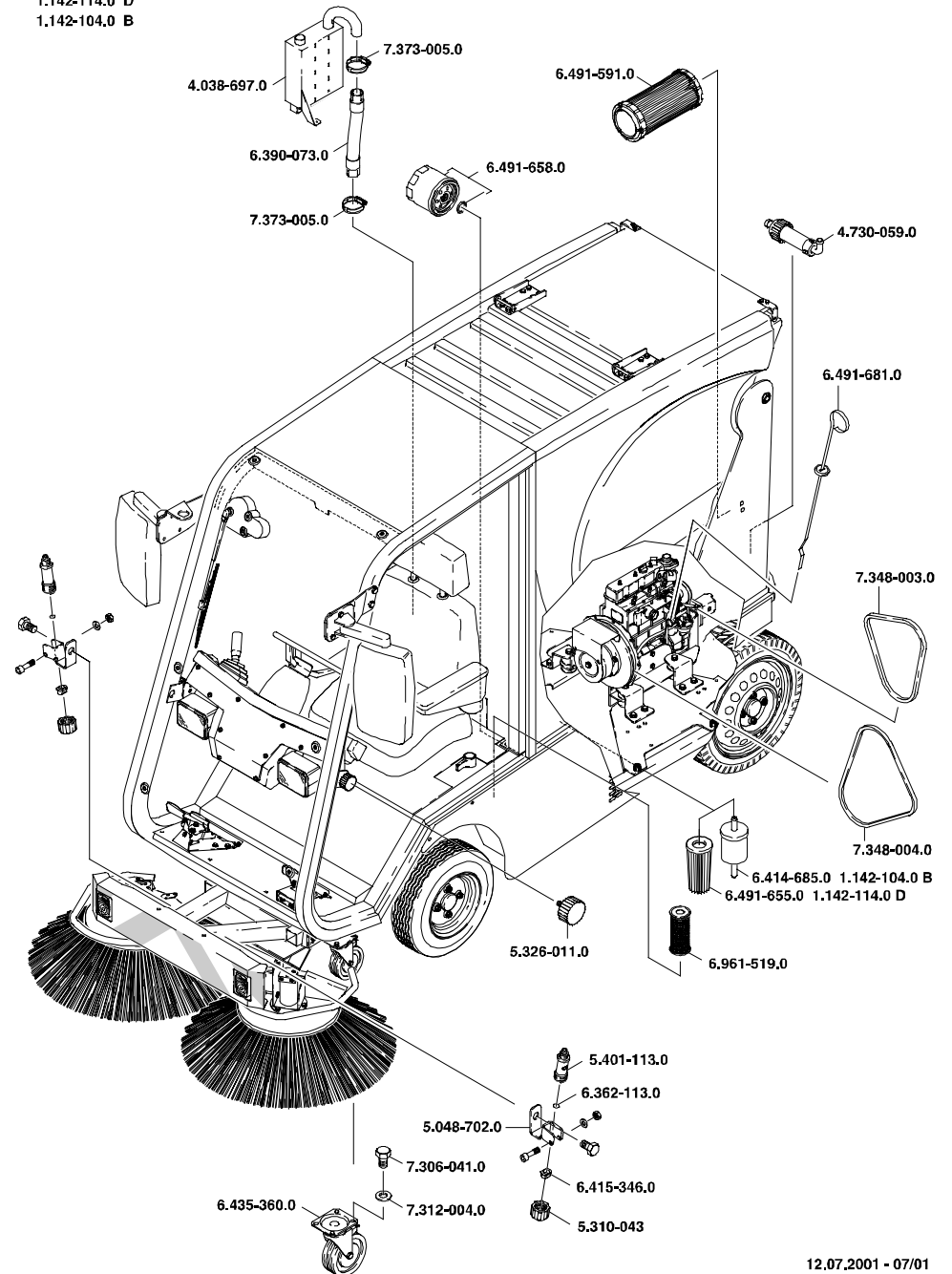

12.07.2001 - 07/01